

RoHS Compliant

REV	DATE	DESCRIPTION	ECN NO.	NAME
B	18.03.29	正式量產		Aaron

G2911-SERIES FAKRA CONNECTOR RECEPTACLE TYPE

NOTE:

- MATERIAL:
PIN/BODY/CRIMP TUBE: BRASS
HOUSING/COVER:
HIGH TEMPERATURE PLASTIC, UL94V-0, COLOR: BLUE
- PLATING:
CONTACT: Au 1~3u"
BODY/CRIMP TUBE: OVER 50 u" MIN. Ni UNDERPLATED OVERALL.
- PACKING: PE BAG
- KEYING CODE (SEE ORDER INFORMATION)
- ORDER INFORMATION:
G-2911-0200XX01-00

CODING CHOOSE

- 00:CODING-C,SIGNAL BLUE
- 01:CODING-A,DEEP BLACK
- 02:CODING-B,CREAM WHITE
- 03:CODING-D,BORDEAUX VIOLET
- 04:CODING-E,LEAF GREEN
- 05:CODING-F,BROWN
- 06:CODING-G,BLUE GRAY
- 07:CODING-H,VIOLET
- 08:CODING-I,BEIGE
- 09:CODING-K,CURRY YELLOW
- 10:CODING-L,CARMINE RED
- 11:CODING-M,PASTEL ORANGE
- 12:CODING-N,PASTEL GREEN
- 13:CODING-Z,WATER BLUE

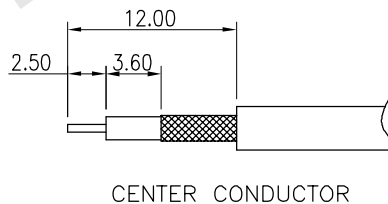
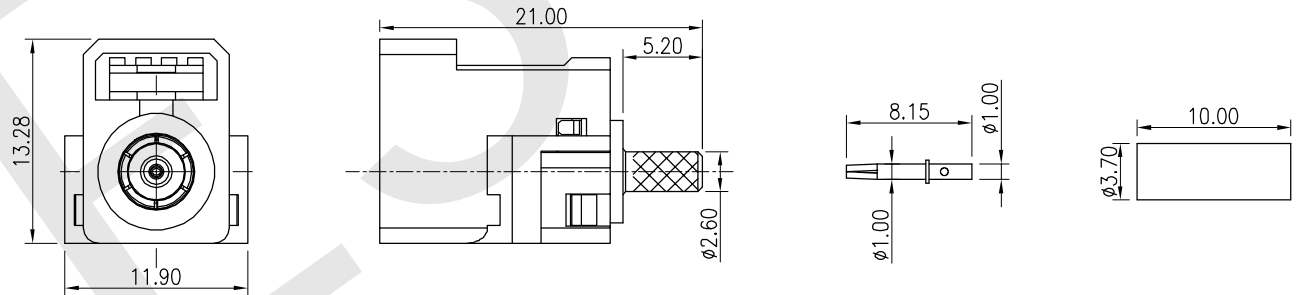
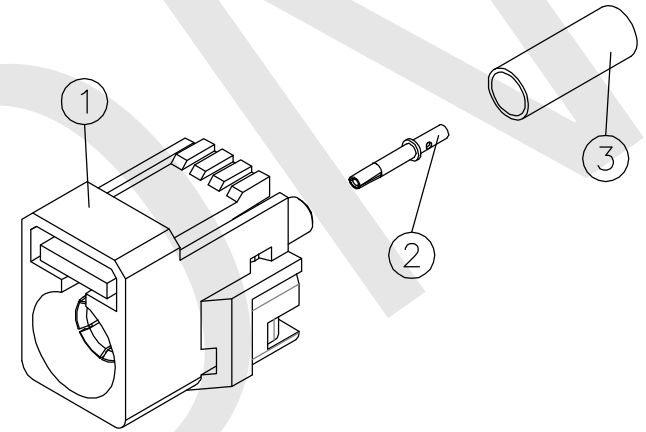

3	CRIMP TUBE
2	REC. PIN
1	FAKRA REC. TYPE

GENERAL TOLERANCE		WIESON TECHNOLOGIES CO., LTD WIESON		PART NO.: G2911-0200XX01-00	
X.X	=±0.20	DRAWN BY	Tony	DRAWING NO.	G2911-0200XX01-00
X.XX	=±0.15	CHECKED BY		DRAWING SIZE	2 : 1 A4
X.X*	=±3'	APPROVED BY		UNIT	mm
		SORTING NO.	WST	PAGE	1 OF 2

RoHS Compliant

REV	DATE	DESCRIPTION	ECN NO.	NAME
B	18.03.29	正式量产		Aaron

G2911-SERIES FAKRA CONNECTOR RECEPTACLE TYPE

A
B
C
D
E

COLDING-A

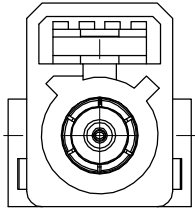

DEEP BLACK (RAL:9005)
G2911-02000101-00

COLDING-B

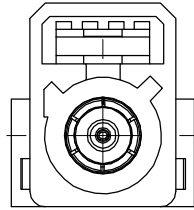

CREAM WHITE (RAL:9001)
G2911-02000201-00

COLDING-C

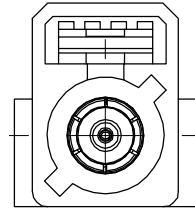

SIGNAL BLUE (RAL:5005)
G2911-02000001-00

COLDING-D

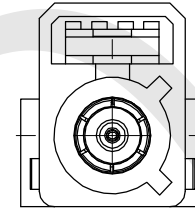

BORDEAUX VIOLET (RAL:4004)
G2911-02000301-00

COLDING-E

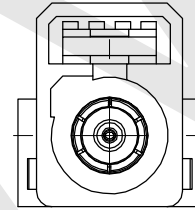

LEAF GREEN (RAL:6002)
G2911-02000401-00

COLDING-F

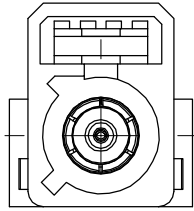

BROWN (RAL:8011)
G2911-02000501-00

COLDING-G

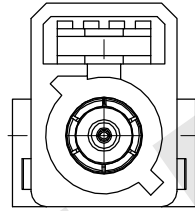

BLUE GARY (RAL:7031)
G2911-02000601-00

COLDING-H

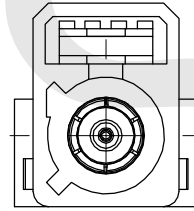

VIOLET (RAL:4003)
G2911-02000701-00

COLDING-I

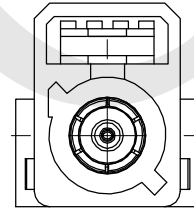

BEIGE (RAL:1001)
G2911-02000801-00

COLDING-K

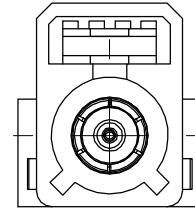

CURRY YELLOW (RAL:1027)
G2911-02000901-00

COLDING-L

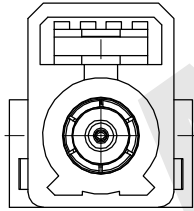

CARMINE RED (RAL:3002)
G2911-02001001-00

COLDING-M

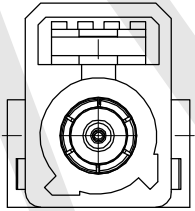

PASTEL ORANGE (RAL:2003)
G2911-02001101-00

COLDING-N

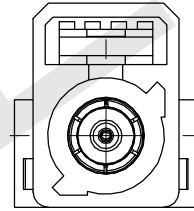

PASTEL GREEN (RAL:6019)
G2911-02001201-00

COLDING-Z

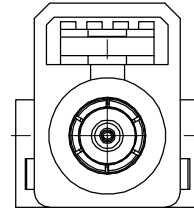

WATER BLUE (RAL:5021)
G2911-02001301-00

GENERAL TOLERANCE	WIESON TECHNOLOGIES CO., LTD WIESON	PART NO.: G2911-0200XX01-00
X.X = ±0.20	DRAWN BY Tony	DRAWING NO. G2911-0200XX01-00
X.XX = ±0.15	CHECKED BY	DRAWING SIZE 2 : 1 A4
X.X* = ±3'	APPROVED BY	UNIT mm
	SORTING NO. WST	PAGE 2 OF 2