

RoHS Compliant

REV	DATE	DESCRIPTION	ECN NO.	NAME
B	18.03.29	正式量產		Aaron

# 2911-SERIES FAKRA CONNECTOR PLUG TYPE

NOTE:

- MATERIAL:  
PIN/BODY/CRIMP TUBE:BRASS  
HOUSING/COVER:  
HIGH TEMPERATURE PLASTIC, UL94V-0, COLOR: SEE ORDER INFORMATION
- PLATING:  
CONTACT: Au 1~3u"  
BODY/CRIMP TUBE: OVER 50 u" MIN. Ni UNDERPLATED OVERALL.
- PACKING: PE BAG
- KEYING CODE (SEE ORDER INFORMATION)
- ORDER INFORMATION:  
G2911-0100XX01-00

- CODING CHOOSE
- 00:CODING-C,SIGNAL BLUE
  - 01:CODING-A,DEEP BLACK
  - 02:CODING-B,CREAM WHITE
  - 03:CODING-D,BORDEAUX VIOLET
  - 04:CODING-E,LEAF GREEN
  - 05:CODING-F,BROWN
  - 06:CODING-G,BLUE GRAY
  - 07:CODING-H,VIOLET
  - 08:CODING-I,BEIGE
  - 09:CODING-K,CURRY YELLOW
  - 10:CODING-L,CARMINE RED
  - 11:CODING-M,PASTEL ORANGE
  - 12:CODING-N,PASTEL GREEN
  - 13:CODING-Z,WATER BLUE

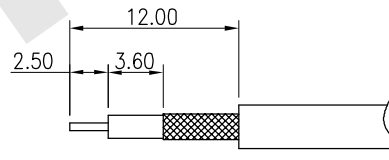
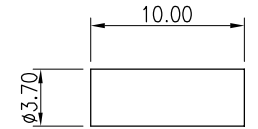
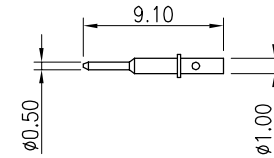
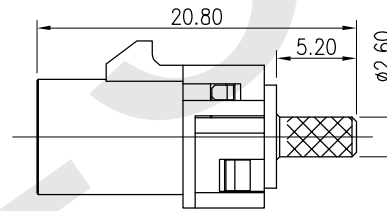
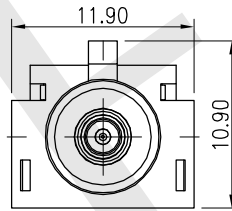
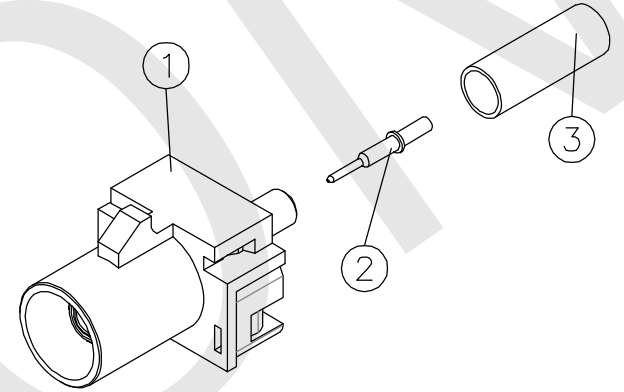

CENTER CONDUCTOR

3	CRIMP TUBE
2	PLUG PIN
1	FAKRA PLUG TYPE

GENERAL TOLERANCE		WIESON TECHNOLOGIES CO., LTD WIESON		PART NO.: G2911-0100XX01-00	
X.X	=±0.20	DRAWN BY	Aaron	DRAWING NO.	G2911-0100XX01-00
X.XX	=±0.15	CHECKED BY		DRAWING SIZE	2: 1   A4
X.X*	=±3'	APPROVED BY		UNIT	mm
		SORTING NO.	WST	PAGE	1 OF 2

**RoHS Compliant**

REV	DATE	DESCRIPTION	ECN NO.	NAME
B	18.03.29	正式量产		Aaron

2911-SERIES FAKRA CONNECTOR PLUG TYPE

A  
B  
C  
D  
E

COLDING-A

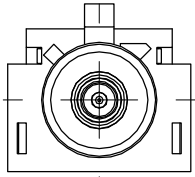

COLDING-B

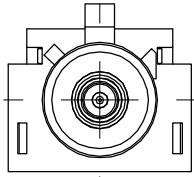

COLDING-C

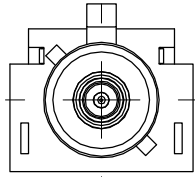

COLDING-D

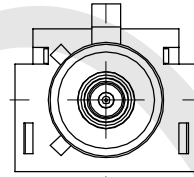

COLDING-E

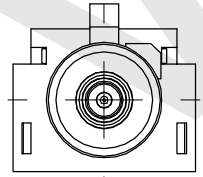

DEEP BLACK (RAL:9005)  
G2911-01000101-00  
COLDING-F

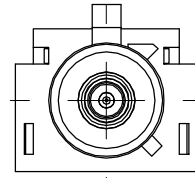

CREAM WHITE (RAL:9001)  
G2911-01000201-00  
COLDING-G

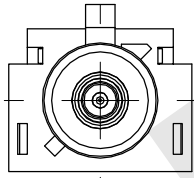

SIGNAL BLUE (RAL:5005)  
G2911-01000001-00  
COLDING-H

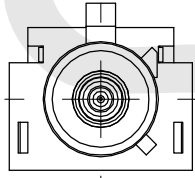

BORDEAUX VIOLET (RAL:4004)  
G2911-01000301-00  
COLDING-I

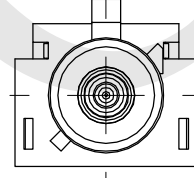

LEAF GREEN (RAL:6002)  
G2911-01000401-00  
COLDING-K

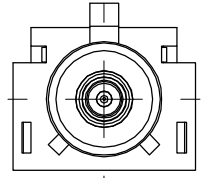

BROWN (RAL:8011)  
G2911-01000501-00  
COLDING-L

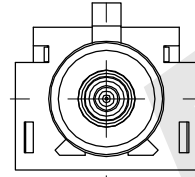

BLUE GARY (RAL:7031)  
G2911-01000601-00  
COLDING-M

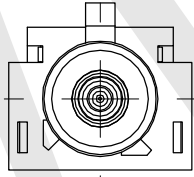

VIOLET (RAL:4003)  
G2911-01000701-00  
COLDING-N

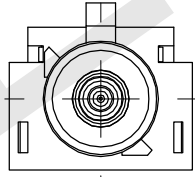

BEIGE (RAL:1001)  
G2911-01000801-00  
COLDING-Z

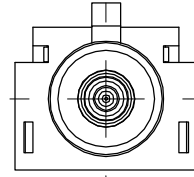

CARMINE RED (RAL:3002)  
G2911-01001001-00

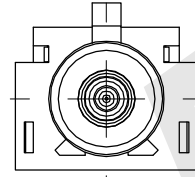

PASTEL ORANGE (RAL:2003)  
G2911-01001101-00

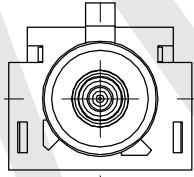

PASTEL GREEN (RAL:6019)  
G2911-01001201-00

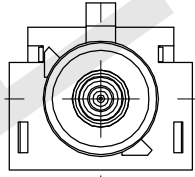

WATER BLUE (RAL:5021)  
G2911-01001301-00

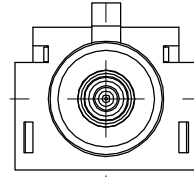

<b>GENERAL TOLERANCE</b> X.X = ±0.20 X.XX = ±0.15 X.X* = ±3°	WIESON TECHNOLOGIES CO., LTD WIESON		PART NO.: G2911-0100XX01-00	
	DRAWN BY	Aaron	DRAWING NO.	G2911-0100XX01-00
	CHECKED BY		DRAWING SIZE	2: 1   A4
	APPROVED BY		UNIT	mm
	SORTING NO.	WST	PAGE	2 OF 2